

**VIEW A**  
TOP VIEW OF AC COMPRESSOR  
AND MOTOR ASSEMBLY  
(SCALE 1:2)

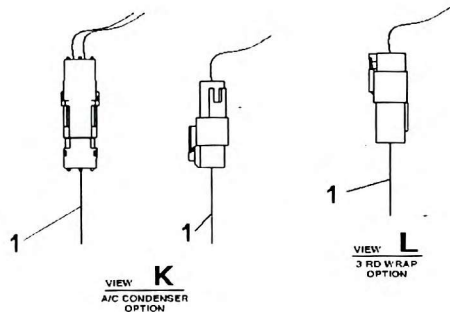

**VIEW K**  
A/C CONDENSER  
OPTION

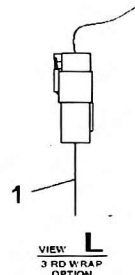

**VIEW L**  
3 RD WRAP  
OPTION

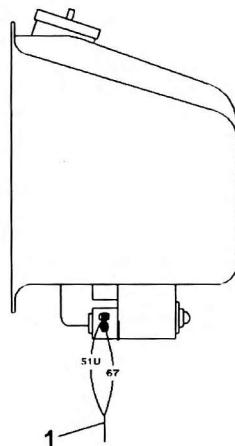

**VIEW P**  
WASHER BOTTLE

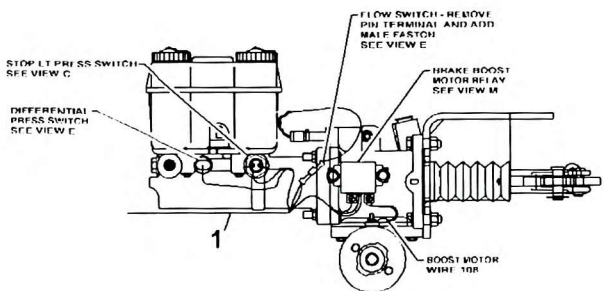

**VIEW B**  
BRAKE BOOST

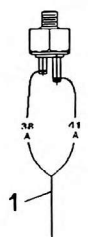

**VIEW C**  
STOP LIGHT  
PRESS SWITCH

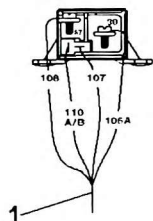

**VIEW M**  
BRAKE BOOST  
PUMP RELAY

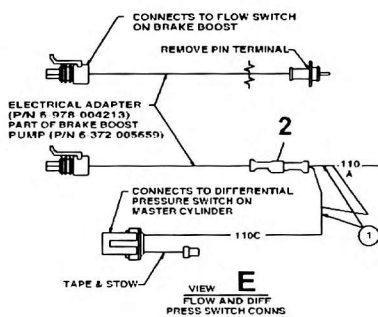

**VIEW E**  
FLOW AND DIFF.  
PRESS SWITCH CONNS

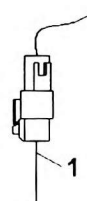

**VIEW F**  
MAIN & AUX HOIST  
ROTATION IND OPTIONS  
SCALE 1:1

